



TECHNICAL DATA

RATED FLOW [M3/H]	8m3/hr
MAX FLOW	12m3/hr
MAX HEAD	113.5M
OPTIMUM OPERATING RANGE	4.8m3/hr @ 105.2m 44.3% eff
	10m3/hr @ 89.5m 61.5% eff
WORKING AIR TEMP	0°C - 40°C
LIQUID TEMPERATURE	-15°C -120°C
HIGHEST EFFICIENCY	64.4%
MAXIMUM PUMP PRESSURE	33 bar
NET WEIGHT (KG)	58.5kg

RATED VOLTAGE/CURRENT	Three phase 415V +10% - 6%
RATED CURRENT	7.56 amps
POWER (KW)	4.0kW 2 pole
MOTOR IP RATING	IP55
MOTOR INSULATION	Class F
MOTOR EFFICIENCY STD	I.E.3
MOTOR EFFICIENCY	88.1%
COS Ø	0.88
MECHANICAL SEAL	AS-L-16
OUTLET DIN FLANGE	DN40

INCLUDES

- VMS Pump
- NXT Drive (Variable Frequency Drive)
- Counter Flange (In DN25 to DN65)
- Fiber Gaskets to suit counter flanges
- Watermarked Spring Check Valve
- Manifold (304 Stainless Steel)
- Pressure Transducer
- 30 Bar Liquid Filled Pressure Gauge
- Galvanised Single/Double/Triple Base
- Ball Valve (304 Stainless Steel)
- Pressure Tank Included in Scope of Supply
- Braided Hose 20 Bar 1.5m 1" BSPF with 10/6 model only

DIMENSIONS

BASE WIDTH & LENGTH 275

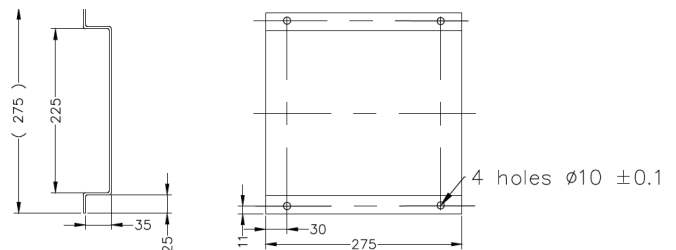

PRODUCT DATA SHEET

SUMMIT SERIES VERTICAL MULTISTAGE

DRIVE KIT

BIA-1VMS10/10T-DRIVE • 812406

CURVE

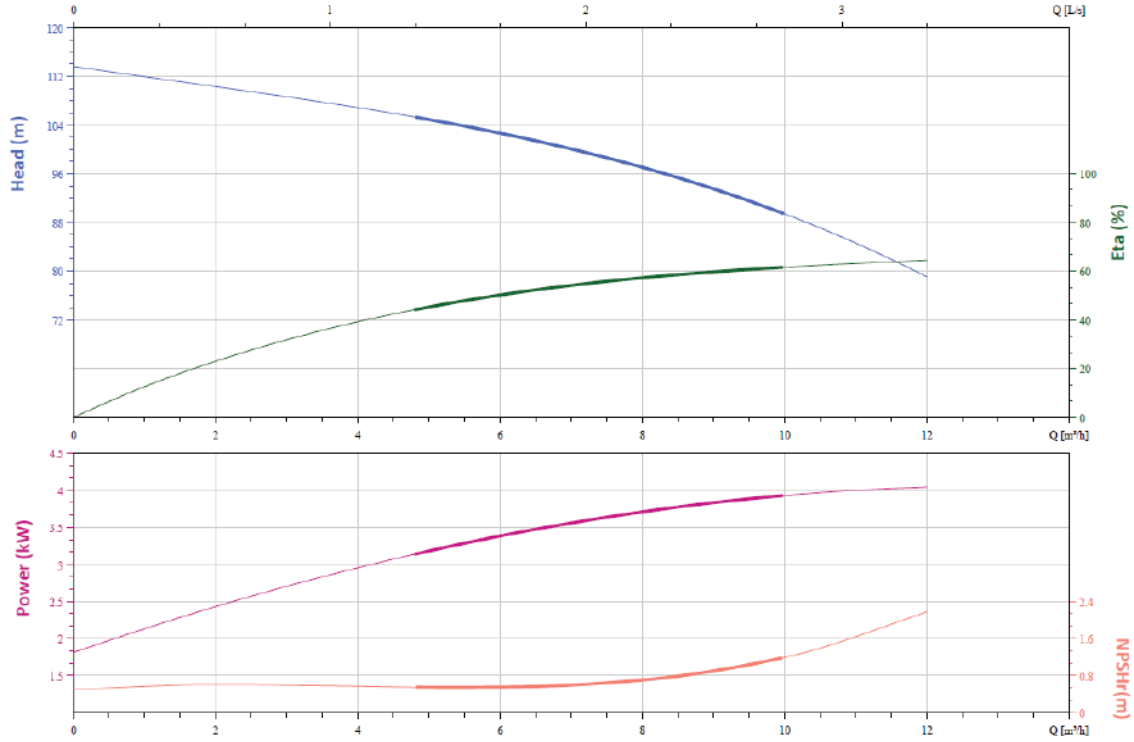

VFD CURVE

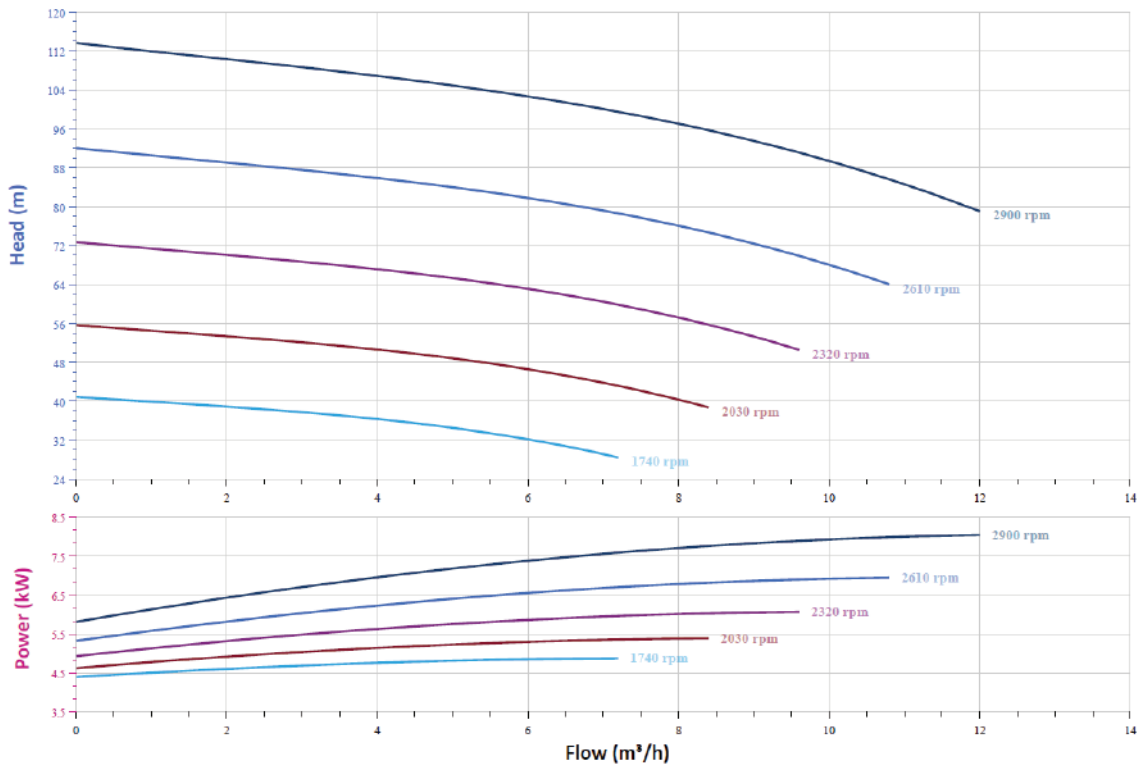

PRODUCT DATA SHEET

SUMMIT SERIES VERTICAL MULTISTAGE

DRIVE KIT

BIA-1VMS10/10T-DRIVE • 812406

DUAL PUMP CURVE

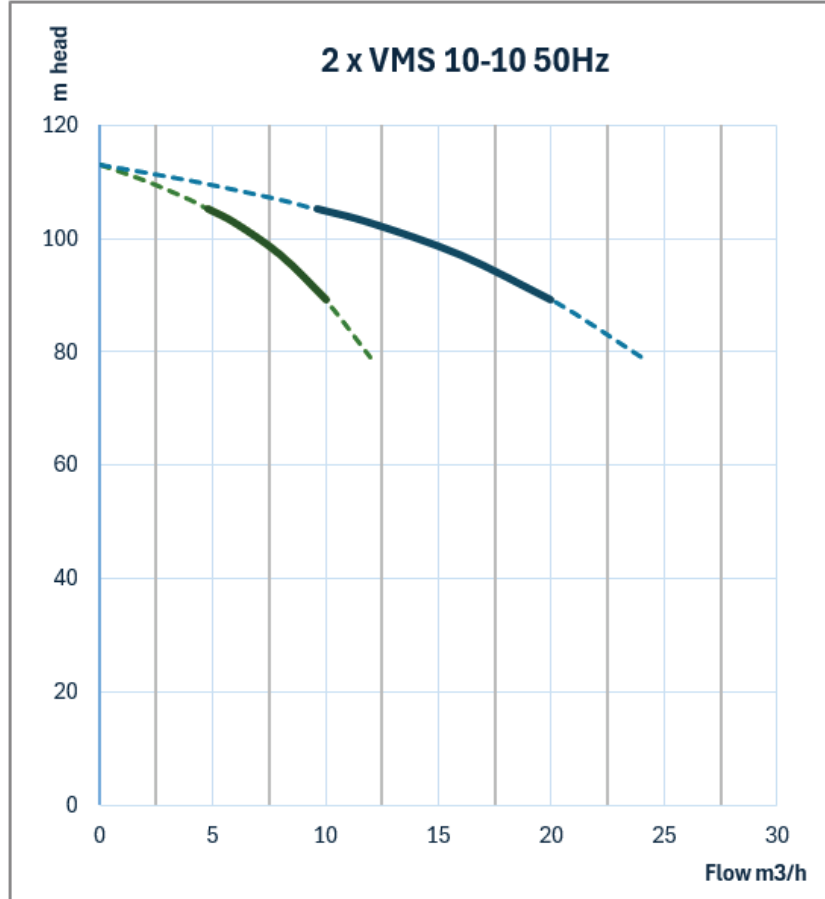

CUTAWAY AND MATERIALS

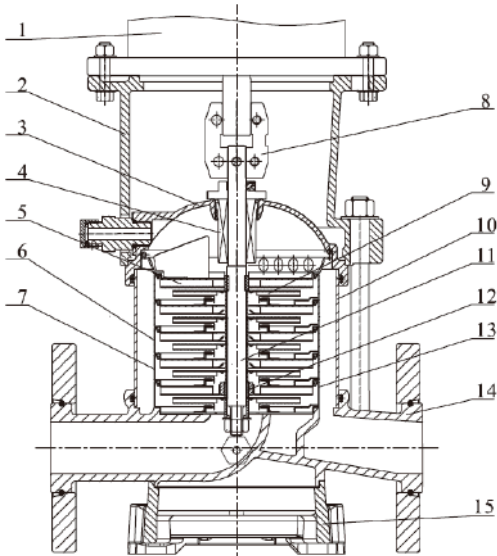

1	Motor	/
2	Bracket	Ductile Cast Iron
3	Seal Base	Stainless / Ductile Cast Iron
4	Mechanical Seal	AS-L-16
5	Top Diffuser	Stainless Steel
6	Diffuser	Stainless Steel
7	Support Diffuser	Stainless Steel
8	Coupling	Stainless Steel
9	Impeller	Stainless Steel
10	Cylinder	Stainless Steel
11	Shaft	Stainless Steel
12	Intermediate Bearing	SIC / WC
13	Inducer	Stainless Steel
14	Inlet/Outlet Chamber	Stainless Steel / Ductile Cast Iron
15	Base	Ductile Cast Iron

PRODUCT DATA SHEET

SUMMIT SERIES VERTICAL MULTISTAGE

DRIVE KIT

BIA-1VMS10/10T-DRIVE • 812406

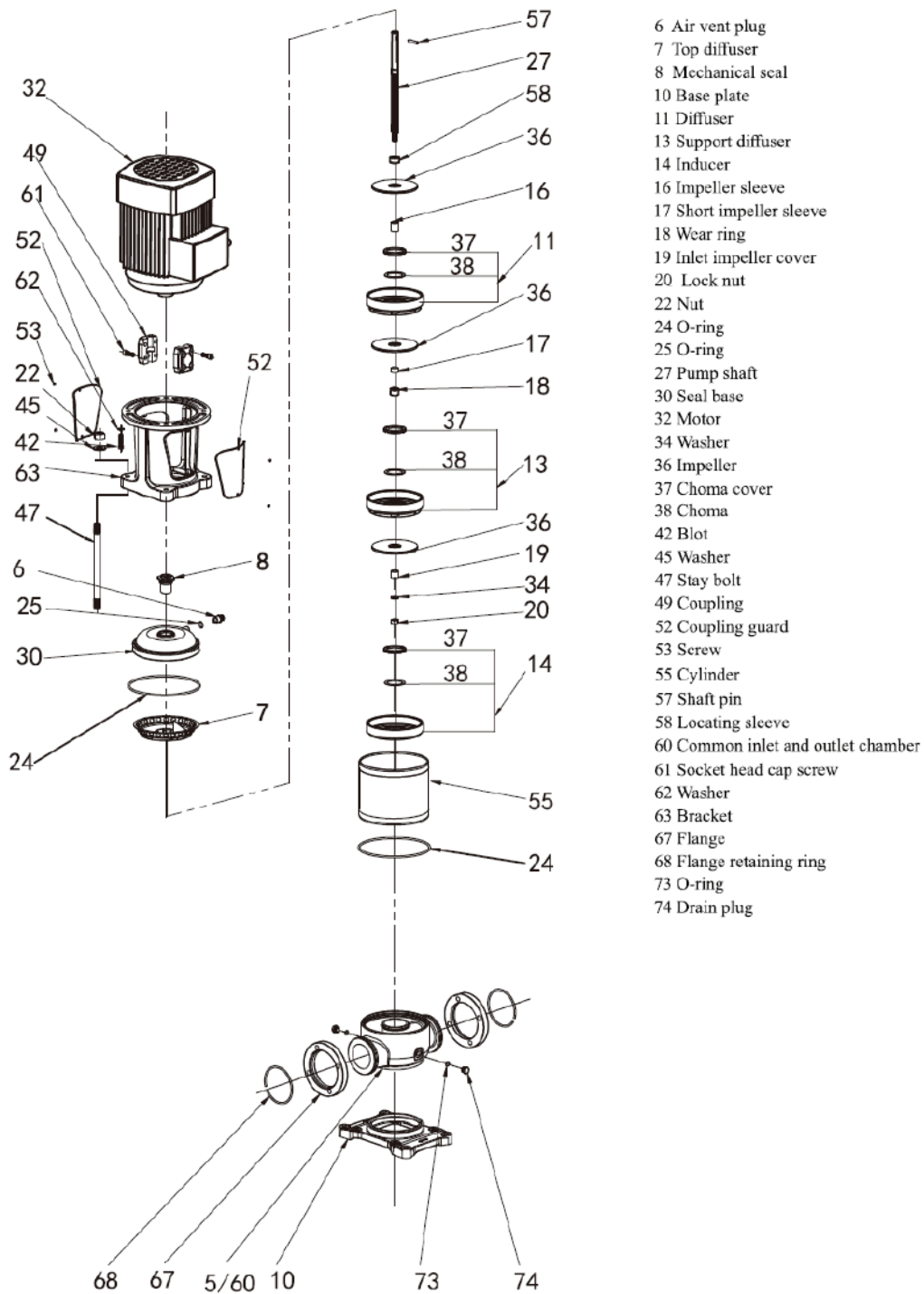

WARRANTY / CERTIFICATIONS

